

Maxi Geocoil - MGC

600-1000 l.

EN



SAFETY INFORMATION
O&M INFORMATION
INSTALLATION MANUAL

Manufactured by **OSO Hotwater AS**
Industriveien 1 - 3300 Hokksund - Norway
Tel: +47 32 25 00 00 / E-mail: oso@oso.no
www.osohotwater.com

11011411-00 - 01-2024

OSO
HOT WATER

CONTENTS

1. Safety instructions	3
1.1 General information.....	3
1.2 Safety instructions for users.....	4
1.3 Safety instructions for installers.....	4
2. Product description	5
2.1. Product identification.....	5
2.2. Intended use.....	5
2.3 CE marking.....	5
2.4 Technical data.....	5
3. Installation instructions	6
3.1. Products covered by these instructions.....	6
3.2. Included in delivery.....	6
3.3. Product dimensions.....	6
3.4. Requirements for installation location.....	7
3.5. Pipe installation.....	8
3.6. Electrical installation.....	10
4. Initial commissioning	12
4.1. Filling with water.....	12
4.2. Turning on the power.....	12
4.3. Control points.....	12
4.4. Emptying of water.....	12
4.5. Handover to end-user.....	12
5. User Guide	13
5.1. Settings.....	13
5.2. Annual inspection.....	13
5.3. Maintenance.....	13
6. Troubleshooting	14
6.1. Faults and fixes.....	14
7. Warranty conditions	15
7.1. Warranty and registration.....	15
7.2. Customer service.....	15
8. Removing the product	15
8.1. Removal.....	15
8.2. Returns scheme.....	15





1. SAFETY INSTRUCTIONS

1.1 General information





- Read the following safety instructions carefully before installing, maintaining or adjusting the buffer tank.
- Personal injury or material damage may result if the product is not installed or used in the intended manner.
- Keep this manual and other relevant documents where they are accessible for future reference.
- The manufacturer assumes compliance (by the end-user) with the safety, operating and maintenance instructions supplied and (by the installer) with the fitting manual and relevant standards and regulations in effect at the date of installation.





Symbols used in this manual:





 WARNING	Could cause serious injury or death
 CAUTION	Could cause minor or moderate injury or damage to property
 DO NOT	
 DO	





1.2 Safety instructions for users

 WARNING	
	The overflow from the safety valve must NOT be sealed or plugged.
	The product must NOT be modified or changed from its original state.
	Children must NOT play with the product or go near it without supervision.
	Maintenance/settings shall only be carried out by persons over 18 years of age, with sufficient understanding

 CAUTION	
	The product must not be exposed to frost, over-pressure, over-voltage or chlorine treatment. See warranty provisions.
	Maintenance/settings shall not be carried out by persons of diminished physical or mental capacity, unless they have been instructed in the correct use by someone responsible for their safety.

1.3 Safety instructions for installers

 WARNING	
	The overflow from the safety valve must NOT be sealed or plugged. Safety valve is supplied with the product.
	The discharge pipe from any safety device shall be at least one pipe size larger than the nominal outlet size of the safety device (< 9m length). The discharge pipe shall have continuous fall to drain, be uninterruptible and frost-free at all times.
	The relevant regulations and standards, and this installation manual, must be followed.

 CAUTION	
	The product shall be placed in a room with a floor drain. The manufacturer assumes no responsibility whatsoever if this provision is not followed.
	The product shall be properly aligned vertically and horizontally, on a floor or wall suitable for the total weight of the product when in operation. See type plate.
	The product must have a clearance for servicing of 40 cm in front of the electric junction box cover/10 cm over the highest point.

2. PRODUCT DESCRIPTION

2.1 Product identification

Identification details for your product can be found on the type plate fixed to the product. The type plate contains details of the product in accordance with EN 12897:2016 and EN 60335-2-21, as well as other useful data. See Declaration of Conformity at www.osohotwater.com for more information.

OSO products are designed and manufactured in accordance with:

- Pressure vessel standard PED 2014/68/EU
- Safety standard EN 60335-2-21
- Welding standard EN ISO 3834-2

OSO Hotwater AS is certified for

- Quality ISO 9001
- Environment ISO 14001
- Work environment ISO 45001

2.2 Intended use

The Maxi Geocoil is designed for use as a buffer for tap water at electrical peak load. The MGC is designed for use with external energy sources.

2.3 CE marking



The CE mark shows that the product complies with the relevant Directives. See Declaration of Conformity at www.osohotwater.com for more information.

The product complies with EU Directives for:

- Low voltage LVD 2014/35/EU
- Electromagnetic compatibility EMC 2014/30/EU
- Pressurised equipment PED 2014/68/EU

The safety valve(s) used must be CE marked and conform to PED 2014/68/EU.

2.4 Technical data

NRF no.	OSO product no.	Product code:	Capacity persons	Weight kg.	Diameter x height mm	Freight vol. m ³	Actual vol. l.
8001011	11009918	MGC 600 - 15 kW (2x7.5) / 3x400V + HX 4.6m ²	-	136	ø 800x2030	1.28	543
8001012	11009922	MGC 1000 - 15 kW (2x7.5) / 3x400V + HX 7.0m ²	-	225	ø1000x2100	2.29	865
Regulation: 2017/1369/EU - Regulation: EU 812/2013			Directive: 2009/125/EC - Regulation: EU 814/2013				
Heat loss tested acc. to standard: EN 12897: 2015							

3. INSTALLATION INSTRUCTIONS

3.1 Products covered by these instructions

Maxi Geocoil - MGC 600

Maxi Geocoil - MGC 1000

3.2 Included in delivery

Ref no.	Number of	Description
1	1	Buffer tank with electrical peak load + coil
2	1	PT valve 10 bar/90-95°C (supplied)
3	1	Anode (factory-fitted)
4	2	Junction box with element/thermostats
5	1	Installation manual (this document)

3.3 Product dimensions

All dimensions in mm.

Product.	A*	B HW	C Coil	D Coil	E CW	∅
MGC 600	2030	1530	1080	260	260	800
MGC 1000	2100	1680	1130	310	310	1000

Tolerance +/- 5 mm.

*Tolerance +50 / -0 mm.

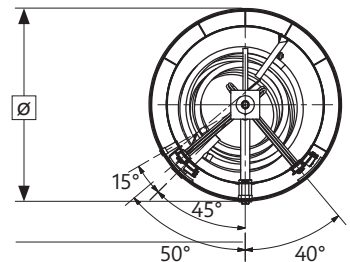
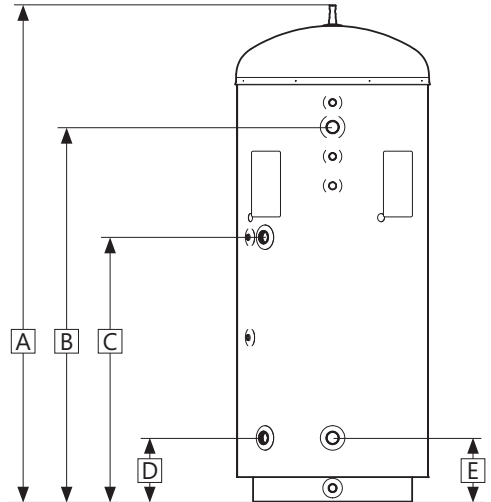
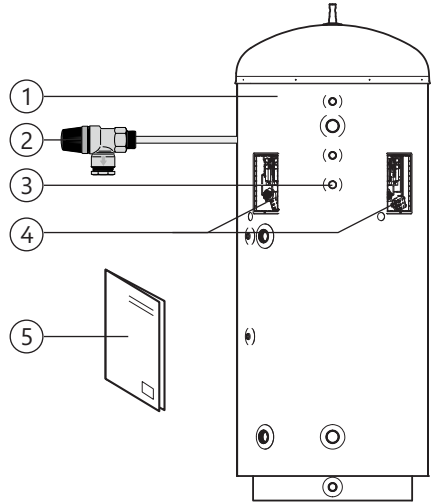

3.3.1 Delivery

The product should be transported carefully, with packaging on. Lifting lug (L) must be used when lifting the product.

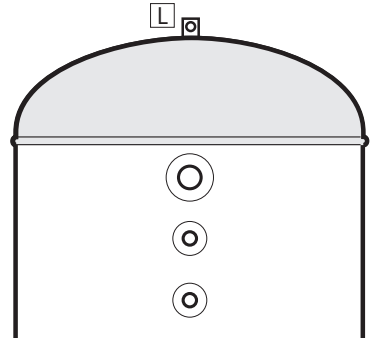

⚠ CAUTION

Pipe stubs, valves etc. should not be used to lift the product as this could cause malfunctions.

3.4 Requirements for installation location and positioning

⚠ CAUTION

- ❗ The product shall be placed in a room with a floor drain. The manufacturer assumes no responsibility whatsoever if this provision is not followed.
- ❗ The product shall be placed in a dry and permanently frost-free position.
- ❗ The product shall be placed on a floor or wall suitable for the total weight of the product when in operation. See type plate.
- ❗ The product must have a clearance for servicing of 40 cm in front of the electric junction box cover/10 cm over the highest point.
- ❗ The product shall be easily accessible for servicing and maintenance.

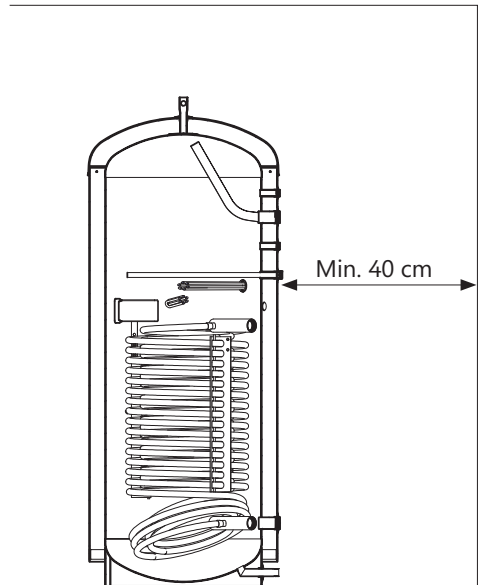
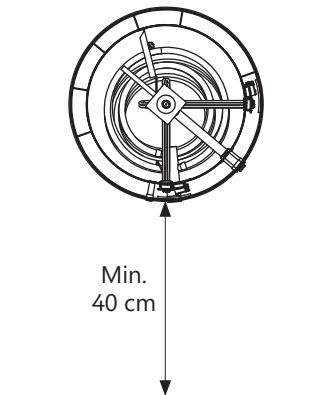

3.5 Pipe installation

The product is designed to be permanently connected to the mains water supply. Approved pipes of the correct size should be used for installation. The relevant standards and regulations must be followed.

No.	Dimension	Connection description
1	G 1 1/2" F	Hot water outlet
2	G 3/4" F	PT valve
3	G 3/4" F	Hot water circulation / thermometer
4	G 3/4" F	Anode
5	G 1 1/2" F	Coil connection, upper
6	G 1/2" F	Sensor slot
7	G 1/2" F	Sensor slot
8	G 1 1/2" F	Coil connection, lower
9	G 1 1/2" F	Cold water inlet
10	G 1" M	Draining

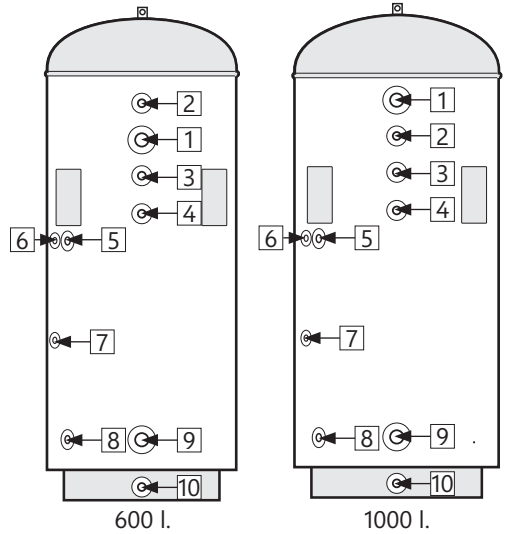

3.5.1 Incoming water pressure, outlet temperature

The efficiency of the product depends on the incoming cold water pressure. The water pressure should be min. 2 bar and max. 6 bar throughout the day. Excessive water pressure can be adjusted by installing a pressure reduction valve. Important: Max. inlet water temperature to the OSO BS mixing valve (optional) is 90°C.

3.5.2 Fitting pipes

- A) Run a pipe of suitable size to the connections shown, and affix with suitable sealant. Unused connections must be plugged securely.
- B) The product can be connected in series for increased capacity in the system.

3.5.3 Fitting of overflow pipe

Overflow pipe (12) of suitable dimension is run to PT safety valve;

- Connect to the overflow (11) of the PT safety valve (3/4" internal thread).
- Fitted uninterrupted, undamaged and frost-free with a fall to the drain.

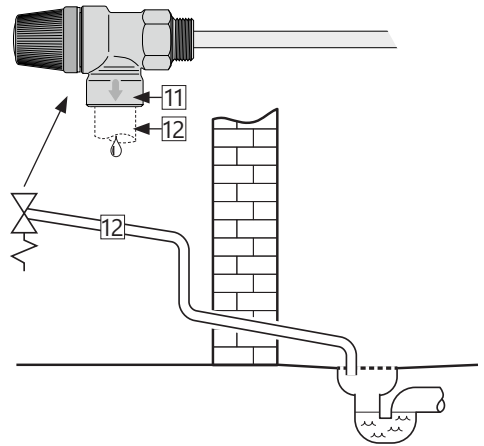

3.5.4 Pressure drop table - coil

Product info:		Pressure drop (mbar) at volume flow:							Cw value (m³/h):
Product	Coil surface m²	540 L/h (0,15L/s)	900 L/h (0,25 L/s)	1800 L/h (0,50 L/s)	2700 L/h (0,75 L/s)	3600 L/h (1,00L/s)	4500 L/h (1,25 L/s)	5400 L/h (1,50 L/s)	Flow @ 1bar pressure drop
MGC 600	4.6	13	29	84	177	307	450	640	
MGC 1000	7.0	3	9	33	79	142	206	290	

3.5.5 Fitting instructions

⚠ CAUTION

❗	The product shall be placed in a room with a floor drain. The manufacturer assumes no responsibility whatsoever if this provision is not followed.
❗	The product shall be properly aligned vertically and horizontally, on a floor suitable for the total weight of the product when in operation. See type plate.
❗	The product must have a clearance for servicing of 40 cm in front of the electric junction box cover/10 cm over the highest point.

3.5.6 Fitting recommendation

RECOMMENDATION

-	If the maximum water pressure exceeds 6 bar in a 24-hour period, a reduction valve and expansion vessel shall be fitted.
---	--

3.6 Electrical installation

Fixed electrical fittings must be used for installation. Any electric fittings must be installed by an authorised electrician. The relevant standards and regulations must be followed.

3.6.1 Electrical components

Component	Note
Safety thermostat	85°C thermal cut-out
Work thermostat	50-75°C adjustable
Heating element	3-phase Δ 230/Y400V
Internal wires	Heat-resistant

3.6.2 Electrical connections in the junction box

⚠ WARNING

Constant voltage present at the terminals. Before any electrical work is done, the power supply must be disconnected and secured against activation while the work is in progress.

- Supply cable connected to terminal (1) as shown. Supply wires should be secured with suitable strain relievers.
- Internal wires from connection piece (1) to thermostats and the wires from thermostats to elements are pre-connected from the factory.
- Make sure that the earth wire (yellow wire with green stripe) is connected to the earthing point (⊕).

Cover of junction box should be correctly mounted before the power is switched on. The power

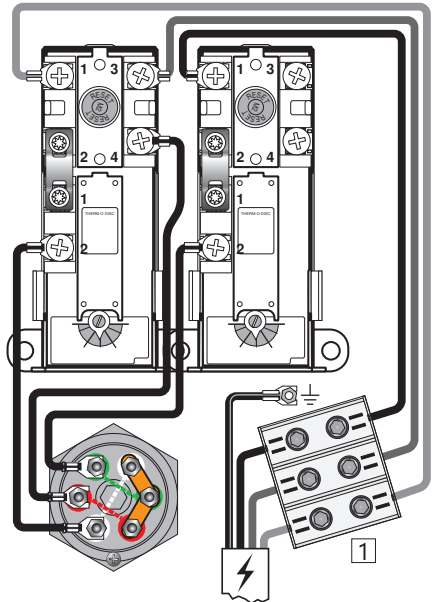

Electrical connection, diagram STANDARD

7.5 kW - 3x400V

The product is fitted with two identical electric junction boxes. NB: Neutral wire is NOT possible!

3.6.3 Torque settings

Component	Torque
G1.1/4" heating element	60 Nm (+/- 5)
Thermostat screws	2 Nm (+/- 0,1)
Screw on the element head	2 Nm (+/- 0,1)
Screws on terminal (1)	2,5-16 mm ² : 3 Nm
	25-35 mm ² : 6 Nm

must not be switched on until the product has been filled with water.

Reduction of electric power output

The power output can be reduced in each electric junction box if desired, see pt. 3.6.4. All electrical installation shall be performed by approved installer.

3.6.3 Torque settings

Component	Torque
G1.1/4" heating element	60 Nm (+/- 5)
Thermostat screws	2 Nm (+/- 0,1)
Screw on the element head	2 Nm (+/- 0,1)
Screws on terminal (1)	2,5-16 mm ² : 3 Nm
	25-35 mm ² : 6 Nm

3.6.4 Reduced electric power output 2,5 - 5 kW

The electric output from each 7.5 kW el. junction box can be reduced to 2,5 or 5 by removing jumpers from the element, see illustration. The electric effect will then be reduced to 1x230V. The product is equipped with two identical junction boxes which both can be altered individually. All electrical installation shall be performed by approved installer.

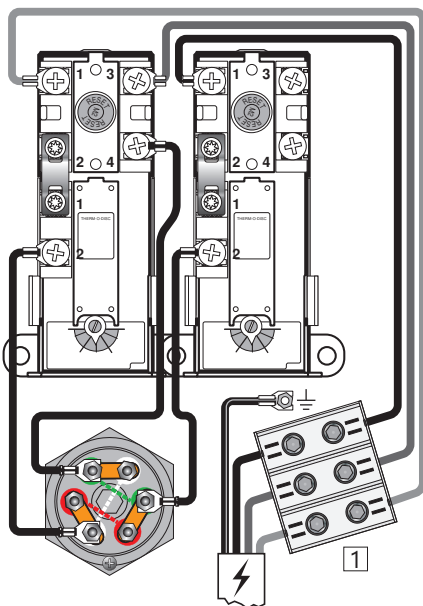

Electrical connection, diagram OPTIONAL

7.5 kW - 3x230V

The product is fitted with two identical electric junction boxes.

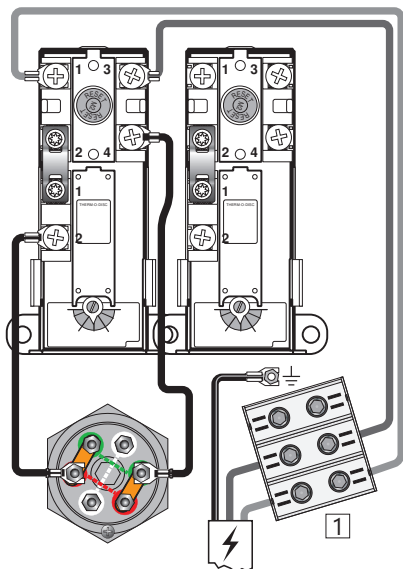

5 kW 1x230V effect:

Wire from the right thermostat to the element is removed. The jumpers on the element is arranged as shown and wires from the left thermostat is fitted as shown. Two of three heating pipes are in use.

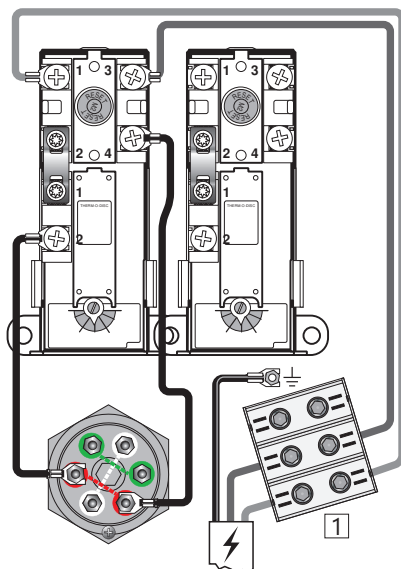

2.5 kW 1x230V effect:

Wire from the right thermostat to the element is removed. The jumpers on the element are removed as shown and wires from the left thermostat is fitted as shown. One of three heating pipes are in use.

3.6.4 Fitting instructions

⚠ WARNING

❗	The product shall be filled with water before the power is switched on.
❗	Fixed electrical fittings must be used for installation according to the regulations. Any electric fittings must be installed by an authorised electrician. Components for disconnection must be integrated in the electric connection in accordance with current standards and regulations.
❗	The mains cable shall withstand 90°C continuously. A suitable strain reliever must be fitted.

⚠ CAUTION

❗	The product must have a clearance for servicing of 40 cm in front of the electric junction box cover/10 cm over the highest point.
❗	In case of damage to the power supply cable, this shall be replaced with new cable with the correct specifications for the installation. All electrical work shall be performed by an authorised electrician.

3.6.5 Fitting recommendation

RECOMMENDATION

-	An authorized electrician shall calculate the correct supply cable and fuse according to the applicable standards and regulations. Make sure all wires are undamaged and are not pinched..
---	--

4. INITIAL COMMISSIONING

4.1 Filling with water

First check that all pipes are connected correctly. Then fill the tank according to the needs/requirements of the system. Make sure that the tank is vented during filling to prevent air pockets.

4.2 Turning on the power

When the cylinder has been filled with water, the power can be switched on.

A) Switch on breaker/fuse.

4.3 Control points

A) Check that all pipe connections to/from the product are tight and not leaking.

B) Check that the power supply to the product is not at risk of exposure to mechanical, thermal or chemical damage.

C) Check that any overflow pipe from the safety valve is clear, undamaged and frost-free with a fall to the drain.

D) Check that the product is standing firmly vertically and horizontally.

4.4 Emptying of water

⚠ WARNING

The water temperature in the product is 75°C and could cause scalding. Before emptying, a hot tap should be opened to the max. pressure/temperature for min. 3 minutes.

A) Disconnect the power supply.

B) Shut off incoming cold water supply.

C) Open a hot tap to the maximum and leave it open (prevents a vacuum).

D) The product is emptied via the drain pipe (5)

After emptying, close the drain pipe (5). Close all open taps.

4.5 Handover to end-user

THE INSTALLER MUST:

Brief the end-user on safety and maintenance instructions.

Brief the end-user on settings and emptying the product.

Hand this installation manual over to the end-user.

Enter contact details on the type plate on the product.

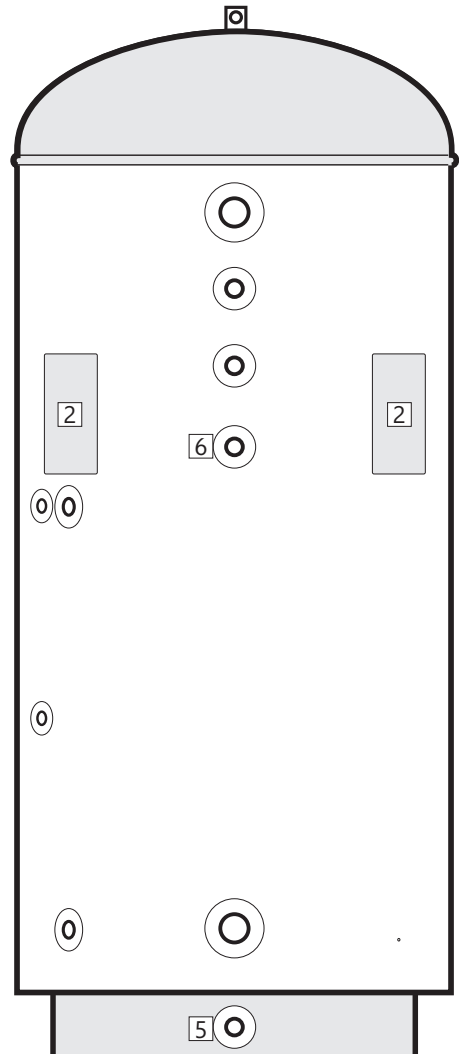

5. USER GUIDE

5.1 Settings

5.1.1 Thermostat setting

The product's thermostats are adjustable from 50-75°C. The thermostat should not be set lower than 60°C to prevent bacteria growth. To adjust the temperature:

- Disconnect the power supply.
- Remove the cover (2) with a screwdriver.
- Adjust the temperature on the thermostats (3) with a screwdriver.

Refit the cover (2) before connecting the power supply.

5.1.2 Resetting the safety thermostat

The safety thermostats on the product cut out when there is a risk of overheating. These are reset by switching off the power supply, removing the cover (2) and pressing the red 'RESET' button (4). If the thermostat cuts out repeatedly, contact the installer.

5.2 Annual inspection

All components fitted in or to the product must be inspected annually. Inspection must be performed by person older than 18 years of age, with appropriate qualifications. Annual inspection includes:

- Checking all connections for leaks. Tighten or maintain properly if required..
- Tighten all connections in the electric junction box:
 - Disconnect power supply and ensure against activation while work is in progress.
 - Remove junction box cover (2) and tighten all connections to the correct torque as shown in table 3.6.3. The junction box cover must be refitted before power is turned back on.
- Inspection of safety valve operation, see pt. 5.3.
- Annual inspection of anode (6):
 - Turn off el. power and water supply.
 - Release water pressure by fully opening a hot water tap. Leave tap open.
 - Drain unit through drain connection (5).
 - Unscrew anode (6). If it is depleted (7) replace with new (8). Fasten to set torque, see pt. 5.2.1.
 - Open water supply, wait until water flows evenly out of open tap. Close tap. Electric power can now be turned on.

⚠ WARNING

Constant voltage is present in the junction box. Before any electrical work is done, the power supply must be disconnected and secured against activation while the work is in progress.

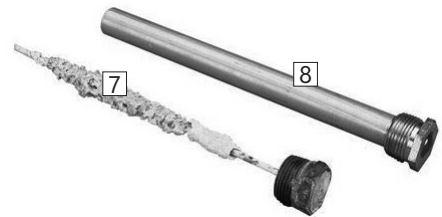
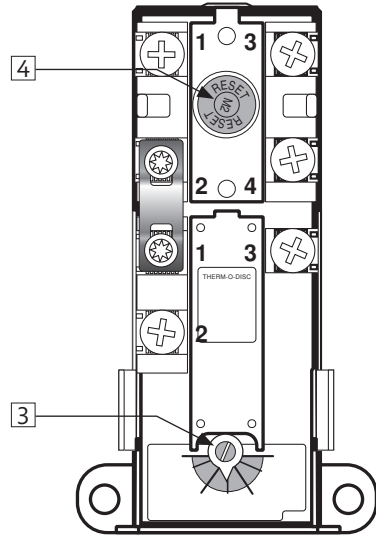

5.2.1 Torque settings

Component	Torque
Anode	30 Nm (+/- 3)

5.3 Maintenance

MAINTENANCE INSTRUCTIONS

⚠	Maintenance shall be carried out by persons over 18 years of age, with sufficient understanding.	
⚠	Annual inspection of safety valve:	
-	Open valve for 1 min. by turning knob (1) approx. 90 degrees counterclockwise to the open position.	
-	Visually check that the water is flowing freely to the drain.	
-	YES = OK. Close the valve by turning knob (1) further counterclockwise.	
-	NO = NOT OK. Disconnect power supply / shut off water supply. Contact installer.	

6. TROUBLESHOOTING

6.1 Faults and fixes

If problems arise when the product is in use, check for possible faults and fixes in the table. If you are unsure what is wrong, contact the

installer (see product type plate) or OSO Hot-water AS - see section 7.1.

TROUBLESHOOTING		
Problem	Possible cause of fault	Possible solution
There is leakage/dripping from the safety valve/there is often water on the floor by the cylinder in the morning	Pressure reduction valve, water meter or blocked non-return valve on the water intake.	Fit AX expansion vessel which absorbs expansion during heating, and fit pressure reduction valve for stable water pressure inside the system. The pressure reduction valve is adjusted in accordance to the pressure in the expansion vessel. Contact auth. installer.
	Water pressure into the system is too high.	
	The safety valve is worn or there are particles stuck between the membrane and the valve seat because the water is dirty	Try to flush with water through the safety valve. Open valve for approx. 1 minute. See section 5.2. If the valve still leaks, it must be replaced. Contact auth. installer.
	Leak from heating element.	Verify as follows: a) cut the electric supply, b) unscrew the cover, c) visually check whether there is a leak from the heating element. If so, replace the gasket/heating element. Contact auth. installer.
No hot water	Power supply interrupted.	Verify that the fuse is on / the plug is plugged in to the wall contact / the earth breaker has not tripped.
	Thermostat has cut out.	Press the 'RESET' button on the safety thermostat; see 'User guide'.
	Heating element is defective.	Replace heating element. Contact auth. installer.
	Leak in hot water pipe	Verify as follows: a) close the water supply, b) wait 2-3 hours, c) feel the tank to see whether it is hot. If so, there is a leak in the hot water pipe or elsewhere. Contact auth. installer.
Not enough hot water	High consumption in the system.	Switch to a larger OSO water heater. Contact auth. installer.
Not high enough temperature	The thermostat is set for low temperatures.	Check the thermostat settings. Turn up to 75°C; see 'User guide'.
	Change from cold to hot water in taps.	Contact auth. installer.
Fuse/earth breaker trips repeatedly	Possible fault in the heater's electrical system.	Verify as follows: a) cut the electric supply, b) unscrew the cover, c) visually check the junction box for any problems. If so, contact auth. installer to check. Fit the cover.
Long time before the water reaches the tap	Long stretch of pipe from water heater to tap.	Fit circulation wire or heating cable to HW pipe. Or fit an auxiliary heater by the tap. Contact auth. installer.
Knocking in the pipes when the hot tap is closed	Large pressure increase when the tap is closed quickly.	Completely normal. Fit AX expansion vessel if troublesome. Contact auth. installer.

7. WARRANTY CONDITIONS

1. Scope

OSO Hotwater AS (hereinafter called OSO) warrants for 2 years from the date of purchase, that the Product will: i) conform to OSO specification, ii) be free from defects in materials and workmanship, subject to conditions below. All components carry a 2-year warranty.

The warranty is voluntarily extended by OSO to 5 years for the stainless steel inner tank. This extended warranty only applies to Products purchased by a consumer, that has been installed for private use and that has been distributed by OSO or by a distributor where the Products have been originally sold by OSO. The extended warranty does not apply to Products purchased by commercial entities or for Products that have been installed for commercial use. These shall be subject only to the mandatory provisions of the law. The conditions and limitations set out below shall apply.

2. Coverage

If a defect arises and a valid claim is received within the statutory warranty period, at its option and to the extent permitted by law, OSO shall either; i) repair the defect, or; ii) replace the product with a product that is identical or similar in function, or; iii) refund the purchase price.

If a defect arises and a valid claim is received after the statutory warranty period has expired, but within the extended warranty period, OSO will supply a product that is identical or similar in function. OSO will in such cases not cover any other associated costs.

Any exchanged Product or component will become the legal property of OSO. Any valid claim or service does not extend the original warranty. The replacement Product or part does not carry a new warranty.

3. Conditions

The Product is manufactured to suit most public water supplies. However, there are certain water chemistries (outlined below) that can have a detrimental effect on the Product and its life expectancy. If there are uncertainties regarding water quality, the local water supply authority can supply the necessary data.

The warranty applies only if the conditions set out below are met in full:

- The Product has been installed by a professional installer, in accordance with the instructions in the installation manual and all relevant Codes of Practice and Regulations in force at the time of installation.
- The Product has not been modified in any way, tampered with or subjected to misuse and no factory fitted parts have been removed for unauthorized repair or replacement.
- The product has been connected to the public power grid and it has not been connected to an external power supply control unit not approved by OSO.
- The Product has only been connected to a domestic mains water supply in compliance with the European Drinking

Water Directive EN 98/83 EC, or latest version. The water should not be aggressive, i.e. the water chemistry shall comply with the following:

- Chloride	< 250 mg / L
- Electric Conductivity (EC) @25°C	< 750 µS / cm
- Saturation Index (LSI) @80°C	> -1,0 / < 0,8
- pH level	> 6,0 / < 9,5

- The immersion heater has not been exposed to hardness levels exceeding 10°dH (180 ppm CaCO₃). A water softener is recommended in such cases.
- Any disinfection has been carried out without affecting the Product in any way whatsoever. The Product shall be isolated from any system chemical disinfecting.
- The Product has been in regular use from the date of installation. If the Product is not intended to be used for 60 days or more, it must be drained.
- Service and/or repair shall be done according to the installation manual and all relevant codes of practice. Any replacement parts used shall be original OSO spare parts.
- Any third-party costs associated with any claim has been authorized in advance by OSO in writing.
- The purchase invoice and/or installation invoice, a water sample as well as the defective product is made available to OSO upon request.

Failure to follow these instructions and conditions may result in product failure, and water escaping from the Product.

4. Limitations

The warranty does not cover:

- Any fault or costs arising from incorrect installation, incorrect application, lack of regular maintenance in accordance with the installation manual, neglect, accidental or malicious damage, misuse, any alteration, tampering or repair carried out by a non-professional, any fault arising from the tampering with or removal of any factory fitted safety components or measures.
- Any consequential damage or any indirect loss caused by any failure or malfunction of the Product whatsoever.
- Any pipework or any equipment connected to the Product.
- The effects of frost, lightning, voltage variation, lack of water, connecting to a non approved external power supply control unit, dry boiling, excess pressure or chlorination procedures.
- The effects of stagnant (de-aerated) water if the Product has been left unused for more than 60 days consecutively.
- Damage caused during transportation. Buyer shall give the carrier notice of such damage.
- Costs arising if the Product is not immediately accessible for servicing.

These warranties do not affect the Buyer's statutory rights.

- A) The installer who supplied the product.
- B) OSO Hotwater AS: Tel.: +47 32 25 00 00
oso@oso.no / www.oso.no

7.1 Customer service

In case of problems that cannot be resolved with the aid of the troubleshooting guide in this installation manual, contact either:

8. REMOVING THE PRODUCT

8.1 Removal

- A) Disconnect the power supply.
- B) Shut off incoming cold water supply.
- C) Empty the product of water – see section 4.4.
- D) Disconnect all pipes.
- E) The product can now be removed.

8.2 Returns scheme

This product is recyclable and should be taken to the environmental recycling centre. If the product is to be replaced with a new one, the installer can take the old cylinder away for recycling.

OSO

HOTWATER

OSO Hotwater AS

Industriveien 1
3300 Hokksund - Norway
Tel: + 47 32 25 00 00
oso@oso.no
www.osohotwater.com

© This installation manual and all its content is protected by copyright and may be reproduced or distributed only with written consent from the manufacturer.
We reserve the right to make changes without notice.